

PRODUCT SPECIFICATIONS

Elkay Crosstown® 18 Gauge Stainless Steel 35-7/8" x 20-1/4" x 9", Equal Double Bowl Farmhouse Sink Kit with Aqua Divide. Sink is manufactured from 18 gauge 304 Stainless Steel with a Polished Satin finish, Rear Center drain placement, and Full spray sides and bottom with Sides and Bottom pads.

| | |
|------------------------------|--|
| Installation Type: | Farmhouse, Sink Kits |
| Material: | 304 Stainless Steel |
| Special Features: | Aqua Divide |
| Finish: | Polished Satin |
| Gauge: | 18 |
| Sound Deadening: | Full spray sides and bottom with Sides and Bottom pads |
| Number of Bowls: | 2 |
| Sink Dimensions: | 35-7/8" x 20-1/4" x 9" |
| Bowl 1 Dimensions: | 14-1/2" x 17" x 9" |
| Bowl 2 Dimensions: | 14-1/2" x 17" x 9" |
| Drain Size: | 3-1/2" (89mm) |
| Drain Location: | Rear Center |
| Minimum Cabinet Size: | 36" |
| Mounting Hardware: | Part # 54300008 included |
| Template Included: | No |



Included with Product: Two custom fit bottom grids, two deep strainer drains, Bar Keeper's Friend cleanser, microfiber towel, all packed in an Elkay protective cloth bag.

Installation Profile:

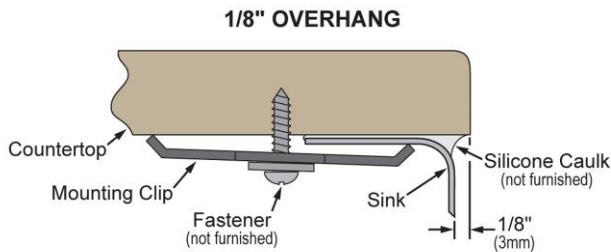

Designed to affix to the underside of any solid surface countertop.

A Century of Tradition and Quality.

For more than 100 years, Elkay has been making innovative products and providing exceptional customer care. We take pride in offering plumbing products that make life easier, inspire change and leave the world a better place.

Product Compliance: ASME A112.19.3/CSA B45.4
Accessory: ASME A112.18.2/CSA B125.2







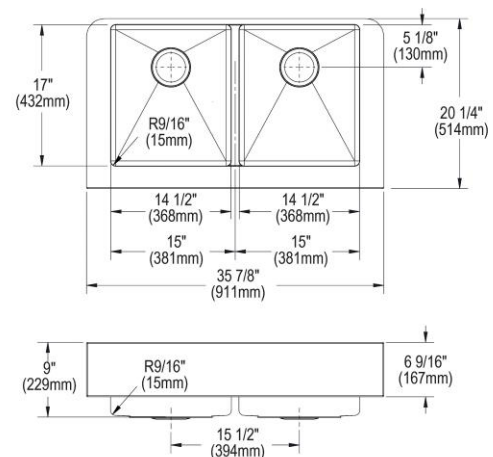

Sinks are listed by IAPMO® as meeting the applicable requirements of the Uniform Plumbing Code®, International Plumbing Code®, and National Plumbing Code of Canada.

[Clean and Care Manual \(PDF\)](#)
[Installation Instructions \(PDF\) - 1000005239](#)
[Installation Instructions \(PDF\) - 1000005235 drain](#)
[Warranty \(PDF\)](#)



PART: _____ QTY: _____
PROJECT: _____
CONTACT: _____
DATE: _____
NOTES: _____
APPROVAL: _____

In keeping with our policy of continuing product improvement, Elkay reserves the right to change product specifications without notice. Please visit elkay.com for the most current version of Elkay product specification sheets. This specification describes an Elkay product with design, quality, and functional benefits to the user. When making a comparison of other producers' offerings, be certain these features are not overlooked.

| Included Accessories | | |
|---------------------------|---|---|
| CTXBG1316 | Elkay Crosstown Stainless Steel 13" x 15-1/2" x 1-1/4" Bottom Grid Spec Sheet (PDF) |  |
| LKDD | Elkay 3-1/2" Drain Fitting Deep Strainer Basket Spec Sheet (PDF) |  |
| Optional Accessories | | |
| LK3000CR | Elkay Everyday Kitchen Deck Mount Faucet with Remote Lever Handle Chrome Spec Sheet (PDF) |  |
| LK3001CR | Elkay Everyday Kitchen Deck Mount Faucet with Remote Lever Handle and Side Spray Chrome Spec Sheet (PDF) |  |
| LK5000CR | Elkay Everyday Single Hole Deck Mount Kitchen Faucet with Pull-out Spray Lever Handle + Optional Escutcheon Chrome Spec Sheet (PDF) |  |
| LK5000LS | Elkay Everyday Single Hole Deck Mount Kitchen Faucet with Pull-out Spray Lever Handle and Escutcheon Lustrous Steel Spec Sheet (PDF) |  |

In keeping with our policy of continuing product improvement, Elkay reserves the right to change product specifications without notice. Please visit elkay.com for the most current version of Elkay product specification sheets. This specification describes an Elkay product with design, quality, and functional benefits to the user. When making a comparison of other producers' offerings, be certain these features are not overlooked.